

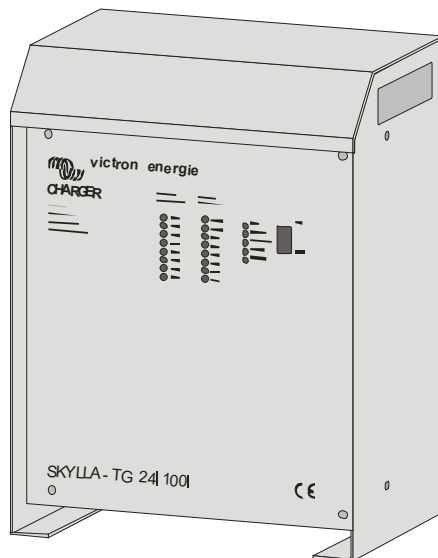

USER MANUAL

SKYLLA-TG 24/30 with Universal Input
SKYLLA-TG 24/50 with Universal Input
SKYLLA-TG 24/100-G with Universal Input



Copyrights © 2010 Victron Energy B.V.
All Rights Reserved

This publication or parts thereof, may not be reproduced in any form, by any method, for any purpose.

VICTRON ENERGY B.V. MAKES NO WARRANTY, EITHER EXPRESSED OR IMPLIED, INCLUDING BUT NOT LIMITED TO ANY IMPLIED WARRANTIES OF MERCHANTABILITY OR FITNESS FOR A PARTICULAR PURPOSE, REGARDING THESE VICTRON ENERGY PRODUCTS AND MAKES SUCH VICTRON ENERGY PRODUCTS AVAILABLE SOLELY ON AN “AS – IS” BASIS.

IN NO EVENT SHALL VICTRON ENERGY B.V. BE LIABLE TO ANYONE FOR SPECIAL, COLLATERAL, INCIDENTAL, OR CONSEQUENTIAL DAMAGES IN CONNECTION WITH OR ARISING OUT OF PURCHASE OR USE OF THESE VICTRON ENERGY PRODUCTS. THE SOLE AND EXCLUSIVE LIABILITY TO VICTRON ENERGY B.V., REGARDLESS OF THE FORM OF ACTION, SHALL NOT EXCEED THE PURCHASE PRICE OF THE VICTRON ENERGY PRODUCTS DESCRIBED HEREIN.

For conditions of use and permission to use this manual for publication in other than the English language, contact Victron Energy B.V.

Victron Energy B.V. reserves the right to revise and improve its products as it sees fit. This publication describes the state of this product at the time of its publication and may not reflect the product at all times in the future.

USER MANUAL SKYLLA UNIVERSAL INPUT

1. INTRODUCTION	5
1.1 Victron Energy	5
1.2 The Skylla Generation chargers	5
1.3 Warnings	6
2. DESCRIPTION	7
2.1 The Skylla battery charger	7
2.2 The battery	8
2.3 Protection	9
3. DIRECTIONS FOR USE	11
3.1 Installation	11
3.2 Operation	14
3.3 Maintenance	15
4. OPTIONS	16
4.1 Permanent boost-charge	17
4.2 Adjusting the charge voltage	17
4.3 Adjusting the equalize-charging mode time	18
4.4 Diode-splitter charge voltage compensation.	18
4.5 Traction battery compensation	19
4.6 Use as a power-supply	19
4.7 Use of a temperature sensor.	19
4.8 Charging batteries with voltage sensing	20
4.9 Intelligent startup	20
4.10 Connecting the output voltage alarm	21
4.11 Connecting remote panels	21
4.12 Connecting a remote on/off switch	22
4.13 Connecting a remote boost switch	22
4.14 Connecting a voltmeter	23
4.15 Connecting a ampèremeter	23
5. FAULT TRACING	24
6. TECHNICAL SPECIFICATIONS	25
6.1 General	25
6.2 Input	25
6.3 Output	26
6.4 Mechanical	27

1. INTRODUCTION

1.1 Victron Energy

Victron Energy has established an international reputation as a leading designer and manufacturer of power systems. Our R&D department is the driving force behind this reputation. This department is continually seeking new ways of incorporating the latest technology in our products.

A Victron Energy power system can supply high-quality energy at places where there is no permanent mains power source available.

An automatic stand alone operating energy supply system can consist of: a Victron Energy inverter, a Victron Energy battery charger, if required a Victron Energy Mains Manager and batteries with sufficient capacity.

Our equipment can be used in numerous situations, in the field, on ships and in other places where mobile power is indispensable.

Victron Energy equipment can be used for all kinds of electrical appliances for household, technical and administrative purposes and instruments susceptible to interference.

1.2 The Skylla Generation chargers

This manual contains directions for installing the following chargers: Skylla-TG 24/30, Skylla-TG 24/50 and the Skylla 24/100-G. It describes the functionality and operation including their protective devices and other technical features.

1.3 Warnings



The cover of the battery charger may only be removed by a qualified technician. Before obtaining access to the battery charger the mains supply circuit must be disconnected.



Explosive gasses can occur during charging a lead-acid battery. Prevent flames and sparks. Provide adequate ventilation during charging.



The battery charger can not be used to charge non-rechargeable batteries.



There is a dangerous voltage present on some of the metal parts inside the battery charger.



The battery charger is NOT protected against reverse battery polarity. ("+" connected to "-" and "-" connected to "+"). Follow the installation procedure. The warranty expires when the battery charger becomes defective due to reverse battery polarity.



The on/off switch at the front of the cabinet does not switch off the mains supply.



Disconnect the mains supply before making or breaking the connections to the battery.



Do not use the voltage sense facility in combination with the diode-splitter compensation. This will raise the output voltage, which could damage the battery.

2. DESCRIPTION

2.1 The Skylla-TG battery charger

The Skylla-TG battery charger is a fully automatic charger for 24V batteries and accepts any mains supply that delivers 90-265 V AC, with frequencies ranging from 45 to 65 Hz. The Skylla-TG also accepts DC supply, ranging from 90 up to 400 V DC.

It charges the battery according to the IUoUo characteristic, which is a 3-stage charging characteristic. This characteristic is shown below in illustration 1.

While charging, the Skylla-TG charger continuously measures the battery voltage and current and recalculates the charging voltage and current based on the measured values.

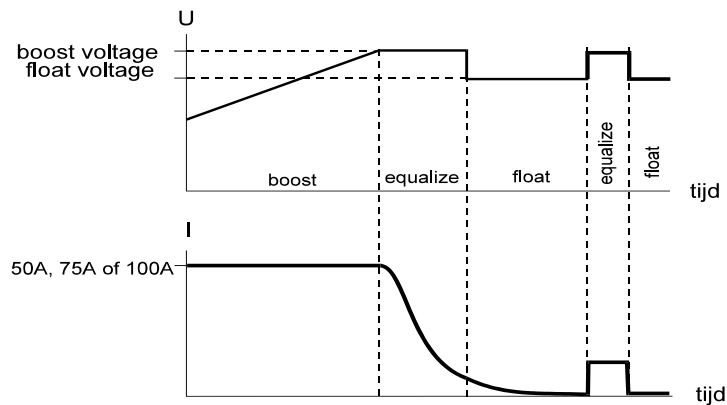

Illustration 1.
The IUoUo charge characteristic.

Type	Boost voltage	Float voltage	Minimal voltage
24V / 30A	28,5 Vdc	26,5 Vdc	25 Vdc
24V / 50A	28,5 Vdc	26,5 Vdc	25 Vdc
24V / 100A-G	28,5 Vdc	26,5 Vdc	25 Vdc

Assuming that the battery is discharged, the Skylla-TG charger commences charging in the boost-charge mode. In this mode the battery is charged until the battery voltage reaches the boost voltage. At this point the battery is charged to approximately 80% of its maximum capacity. This is the end of the boost-charge mode and the Skylla-TG charger then automatically switches to the equalize-charge mode.

During the equalize-charge mode the charging voltage still equals the boost voltage, but the charge current slowly decreases. The duration of this mode is pre-selectable and may be set to 4, 8 or 12 hours. The standard time of the equalize-mode is 4 hours. After this time the Skylla-TG charger automatically switches back to the float-charge mode.

In the float-charge mode the charge voltage decreases to the float voltage and the charge current continues to decrease. This mode lasts for 20 hours.

After the float-charge mode the charger returns to the equalize-charge mode for 30 minutes, this is to compensate for the normal leakage or self discharge of the battery.

The Skylla-TG charger can remain connected to the battery continuously, without gas formation taking place, caused by overcharging. It is not necessary to disconnect the battery from the charger during long time storage, for example during the winter storage of a ship. The Skylla-TG charger will keep your battery in optimum condition under all circumstances and will prolong the lifetime of your battery.

A parallel load connected to the battery can cause a voltage drop. The Skylla-TG charger automatically switches into the boost-charge mode when the battery voltage drops below the minimal voltage.

The Skylla-TG charger is equipped with a separate starter-battery connection to charge an extra battery, like a starter-battery. You can use this battery for starting machines, like a boat engine for this application.

The Skylla-TG charger has a stabilised output voltage. Therefore the Skylla-TG charger can also be used as a DC power supply in applications where no battery is present.

2.2 The battery

The Skylla-TG charger can charge various batteries. The recommended battery capacity is indicated in the table below:

Type	Recommended capacity
24V / 30A	100 – 200 Ah
24V / 50A	200 – 400 Ah
24V / 100A-G	500 - 1000 Ah

The charge voltages of the Skylla-TG charger are factory-set. Most battery manufacturers recommend these charging voltages for optimal charging of 24V or 48V lead-acid batteries.

It is possible to charge different types of batteries, like traction batteries. To charge these batteries the charging voltages of the charger have to be changed. Contact your Victron Energy dealer or battery dealer for more details about the recommended charging voltages.

2.3 Protection

The battery charger is safe to use due to its robust design and its internal electronic protection. This chapter describes the various internal electronic protective devices.

Maximum charge current protection

- ❑ The battery charger provides a maximum charge current of 30A for the 30A charger, 50A for the 50A charger or 100A for the 100A charger. This level is electronically limited and is factory set.
- ❑ The maximum output current can also be limited by using an external potentiometer-panel, the Victron Energy COV panel.

Short circuit protection

- ❑ The charger output is protected against short-circuits. The short-circuit current is electronically limited at 30A, 50A or 100A, according to the model. In this condition the output voltage approaches 0 Volt. The battery charger resumes normal operation when the short circuit is removed.
- ❑ The short circuit current can also be reduced by the Victron Energy COV panel.

Input protection

- ❑ The charger mains-input is protected with a fuse.
- ❑ The charger will not be damaged by using input voltage between 0 and 300 Vac.
- ❑ The charger will not be damaged by using input frequency between 0 and 65 Hz.

Over voltage protection

- ❑ The charger switches off automatically when the battery voltage becomes higher than the over voltage value. The charger switches back on when the battery voltage becomes less than the raise value. See the table below.

Model	Over voltage value	Raise value
24V	35,5 Vdc	33,5 Vdc

- ❑ The charger output is protected with a fuse.

Starter battery protection

- ❑ The output current of the starter battery output is electronically limited at 4A. The starter battery output is also protected against wrong connections by means of a 10A fuse.

Temperature protection

- ❑ The internal temperature of the charger is measured continuously. However, due to a high ambient temperature outside the cabinet, the temperature within the battery charger can rise. When the external temperature of the battery charger becomes higher than 40°C, the output current decreases and the Failure led flashes.
- ❑ Before the internal temperature becomes too high due to extreme conditions the charger switches off and the Failure LED illuminates continuously. The charger resumes operation when the internal temperature is restored within limits.

Voltage sense protection

- ❑ When the voltage sense facility is used the charger automatically decreases the output voltage when the voltage loss over the battery cables is more than 2 Volt in total.

Battery watchdog timer

- ❑ The charger is equipped with a battery watchdog timer. This timer measures the duration of the boost mode. The moment the boost mode lasts longer than 10 hours, the charger will switch to float mode. The charging voltage will then become the float voltage. In this way it is prevented that a defective battery is needlessly charged with a high charging voltage.

3. DIRECTIONS FOR USE

3.1 Installation

Find a dry and well-ventilated area to mount the Skylla charger and battery. Keep the distance between the charger and the battery less than 6 meters.

The charger may be wall or floor mounted. Mounting on a wall improves the air circulation within the charger cabinet and will prolong the lifetime of the battery charger.

The holes for the mains cable, the battery connections, the remote connections and the earth connection are located at the bottom of the battery charger housing, see illustration 2.

*Illustration 2,
Location of the charger
connection holes*

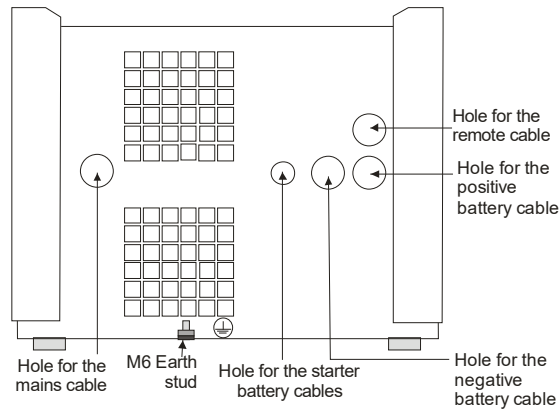

Connecting earth

Connect the earth screw to a real earth-point. Connections to earth have to be according to applicable safety standards.



- On a ship: Connect the earth screw to the earth plate or to the hull of the ship.
- On land: Connect the earth screw to the earth of the mains.
- Mobile applications (a vehicle, a car or a caravan): Connect the earth screw to the frame of the vehicle.

Connecting the battery

The connections between the Skylla charger and the battery are essential for a good operation of the charger. Therefore the battery connections need tightening well. It is important to use short and thick battery cables to minimise the voltage losses in the cable. Cable resistance decreases accordingly as the cables become shorter and thicker. Therefore it is not recommended to use cables longer than 6 meters. The table below shows the recommended cable core thickness.

Type	core diameter of cables until 1,5m	core diameter of cables between 1,5m and 6m
24/30	6 mm ²	10 mm ²
24/50	10 mm ²	16 mm ²
24/100	35 mm ²	50 mm ²

The battery connection sequence

 WARNING	<p>The Skylla is NOT protected against reverse battery polarity. ("+" connected to "-" and "-" connected to "+"). Follow the installation procedure. The warranty expires when the Skylla becomes defective due to reverse polarity.</p>
 CAUTION	<p>Disconnect the mains supply before making or breaking connections to the battery.</p>
 CAUTION	<p>The on/off switch at the front of the cabinet does not switch off the mains supply.</p>

- ❑ Check if the charger is switched off and if the mains supply is disconnected.
- ❑ Remove the front of the battery charger to access the battery connections.
- ❑ If not placed, place the connection tool to the negative battery connection (-) of the charger, see illustration 3.
- ❑ Connect the positive battery-cable (+) to the positive battery connection terminal on the charger printed circuit board, see illustration 3.
- ❑ Hook the negative battery-cable (-) to the connection tool, see illustration 3.
- ❑ Check if the green led illuminates, see illustration 3. If not the positive and negative battery cables have been reversed.
- ❑ Disconnect the connection tool and connect the negative battery cable (-).

The battery disconnection sequence

- ❑ Switch off the charger.
- ❑ Disconnect the mains supply.
- ❑ Disconnect the negative battery-cable.
- ❑ Disconnect the positive battery-cable.

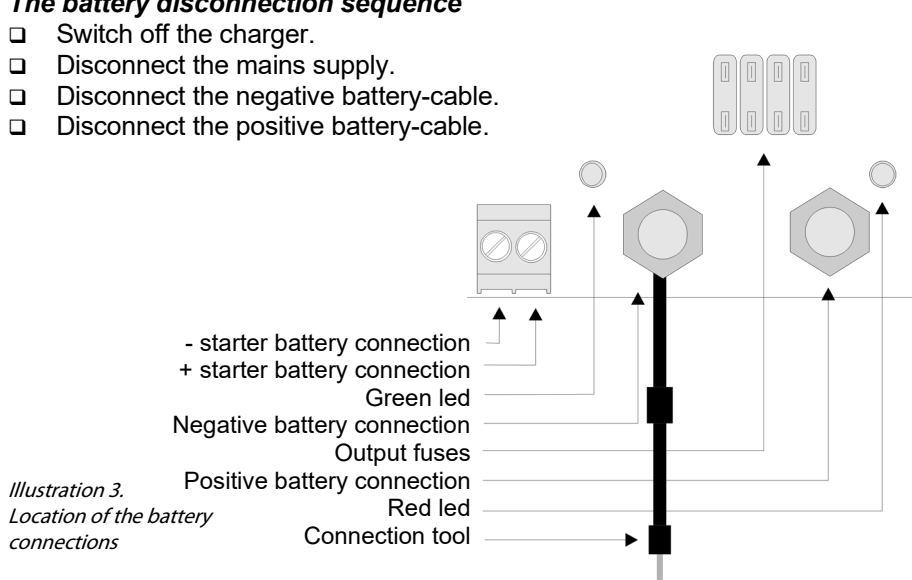

Connecting the starter battery

The starter battery has to be connected using wire with a core of at least 1.5 mm².

- ❑ Connect the positive (+) battery-pole to the right side of the starter battery connector, see illustration 3.
- ❑ Connect the negative (-) battery-pole to the left side of the starter battery connector, see illustration 3.

Connecting the mains

- ❑ Check if the battery is already connected to the charger.
- ❑ Remove the front of the battery charger to access the AC input connector.
- ❑ Connect the mains PE cable (green/yellow) to the AC input connector located on the circuit board, see illustration 4.
- ❑ Connect the mains neutral cable (blue) to the AC input connector.
- ❑ Connect the mains line cable (brown) to the AC input connector.
- ❑ Plug the mains cable into the mains socket. Make sure that the mains socket is connected to earth. The connection to the earth of the mains has to be according to applicable safety standards.

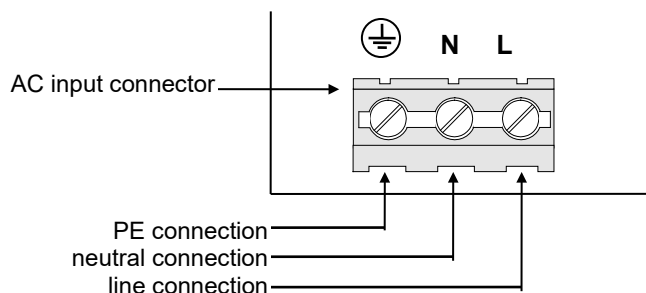

Illustration 4.
Location of the
AC input connector.

3.2 Operation

Located on the front of the Skylla charger are an on/off switch and three rows of leds, as shown in illustration 5.

The battery charger can be switched on and off with the on/off switch.

The “output voltage” leds indicate the output voltage value.

The “output current” leds indicate the output current value.

The other leds indicates the state of the charger.

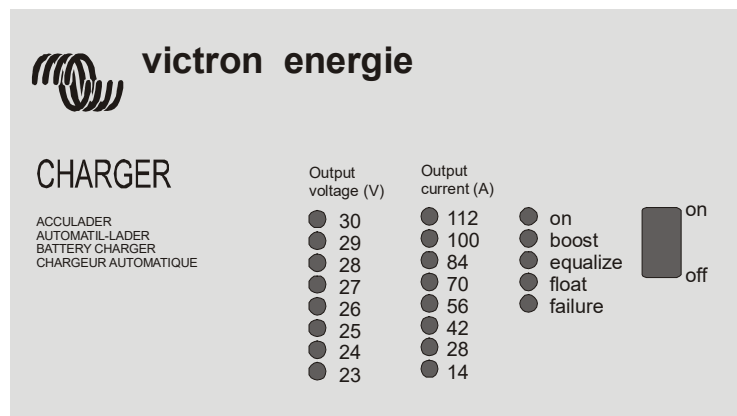

Illustration 5. Example of the battery charger front panel.

The operation sequence:

	Explosive gasses can occur during charging a lead-acid battery. Prevent flames and sparks. Provide adequate ventilation during charging.
--	--

Switching the charger on with the on/off switch results in the following:

- ❑ The “on” led will flash for about 2 seconds. In these first 2 seconds the charger reads all input signals and calculates the necessary output voltage. After 2 seconds the charger will switch on and the “on” led illuminates.
- ❑ According to the condition of the battery the charger will start in the boost-charge mode or at float-charge mode. If the battery is not full the “boost” led illuminates and the charger will start boost-charging the battery.
- ❑ A dip switch can be used to set the charger so that it will always start charging in the boost mode, irrespective of the condition of the battery.
- ❑ When the battery voltage has reached the boost voltage the charger will change into the equalize-charge mode and the “equalize” led illuminates. This mode will last for a pre-selectable time of 4, 8 or 12 hours.
- ❑ After this time the charger will enter the float-charge mode and the “float” led will illuminate.

After the batteries are charged the Skylla charger does not have to be switched off and the batteries can stay connected to the battery charger.



3.3 Maintenance

The Skylla charger does not require any specific maintenance. However an annual check of the battery connections is recommended.

Keep the charger dry, clean and free of dust. If any problems arise, use the fault finding procedure to trace the fault, see chapter 5.

4. OPTIONS

The Skylla charger is factory set to standard values. Some of these standard values can be changed by a qualified electrical technician into customised values. This chapter describes which values can be changed and how to change them.

 WARNING	The cover of the Skylla may only be removed by a qualified technician. Before obtaining access to the Skylla the mains supply circuit must be disconnected.
 WARNING	There is a dangerous voltage present on some of the metal parts inside the battery charger.
 CAUTION	Attention ! The value of the potentiometers I, Vboost and Vfloat may only be adjusted by a qualified electrician. The remaining potentiometers may not be adjusted at any case.

Opening of the battery charger cabinet

In order to change the standard values the front of the charger has to be removed.

- Disconnect the mains from the charger and wait two minutes.
- Unscrew the 4 screws on the front of the cabinet, see illustration 6.
- Remove the front panel of the battery charger.

Adjustments can be made by means of turning a potentiometer or by changing the position of a switch on the DIP-switch.

See illustration 7 for the location of the DIP-switch and the potentiometers.

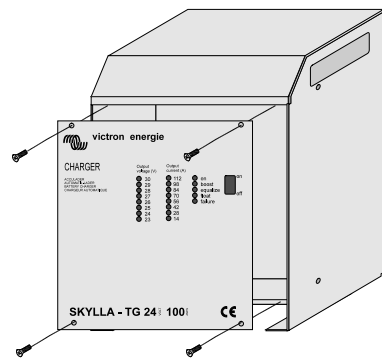

Illustration 6.
Removing the front.

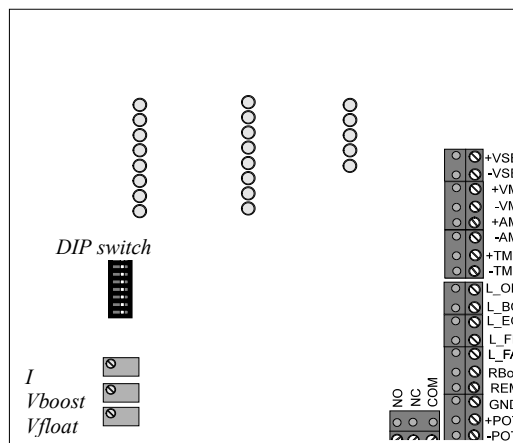

Illustration 7.
Location of the DIP-switch and potentiometers.

4.1 Permanent boost-charge

In some cases, for example when the battery is almost empty, it is recommended to permanent boost-charge the battery for 10 hours. Do not permanently boost-charge sealed lead-acid batteries. Contact your Victron Energy dealer or battery dealer for more information on charging the battery.

To set the charger into the permanent boost-charge mode:

- ❑ Place the DIP switch number 8 “R boost” to the left. In this mode the battery is being charged to the boost voltage.
- ❑ Do not permanent boost-charge the battery for longer than 10 hours as this can cause long term gas formation in the battery and will damage the battery.
- ❑ While a battery is being boost-charged, check the water level of the battery frequently and if necessary add distilled water to the battery.

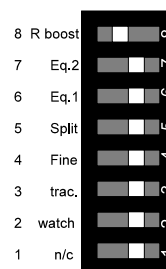

4.2 Adjusting the charge voltage

The battery charger has a factory set float and boost voltage. The boost-voltage is always higher than the float-voltage. These charging voltages are the recommended values from almost every battery manufacturer. Before adjusting the charge voltage disconnect the temperature sensor and/or the voltage sense wires.

To change the float-voltage:

- ❑ Remove all batteries and other users that are connected to the output of the battery charger.
- ❑ Plug the AC plug into the mains and switch on the charger.
- ❑ Place DIP-switches 7 “Eq2” and 6 “Eq1” to the left position, this will reduce the equalize time to 0 hours. The charger switches into the float-charge mode.
- ❑ Place DIP-switch 4 “fine” to the left position in order to accurately adjust the output voltage.
- ❑ Measure the float-voltage on the charger output by using a precision voltage meter.
- ❑ Adjust the float-voltage by turning the “V float” potentiometer until the recommended voltage is reached.
- ❑ Correct the equalize time by moving DIP-switch 7 “Eq2” and 6 “Eq1”.
- ❑ Place DIP-switch 4 “fine” to the right position. In this position the output voltage is less sensitive to influence of temperature.

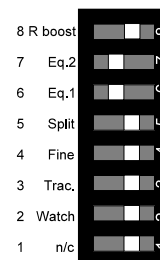

To change the boost-voltage:

- Place DIP-switch 7 “Eq2” to the right and place DIP-switch 8 “R boost” to the left. The charger switches into the boost-charge mode.
- Place DIP-switch 4 “fine” to the left position in order to accurately adjust the output voltage.
- Measure the boost-voltage on the charger output by using a precision voltage meter.
- Adjust the boost-voltage by turning the “V boost” potentiometer until the recommended voltage is reached.
- Replace DIP-switch 8 “R boost” to the right.
- Correct the equalize time by moving DIP-switch 7 “Eq2” and 6 “Eq1”.
- Place DIP-switch 4 “fine” to the right position. In this position the output voltage is less sensitive to influence of temperature.

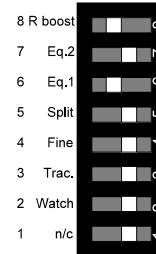

4.3 Adjusting the equalize-charging mode time

The duration of the equalize-charge mode can be changed to fit the specifications of the battery. The duration of the equalize-charge mode can be set to 0, 4, 8 or 12 hours. When selecting 0 hours, the charger will skip the equalize-charge mode and will directly switch into the float-charge mode. The standard equalize-time is 4 hours.

According to the table below the duration of the equalize-charge mode can be set by moving the DIP-switches 7 “Eq2” and 6 “Eq1” in the corresponding way:

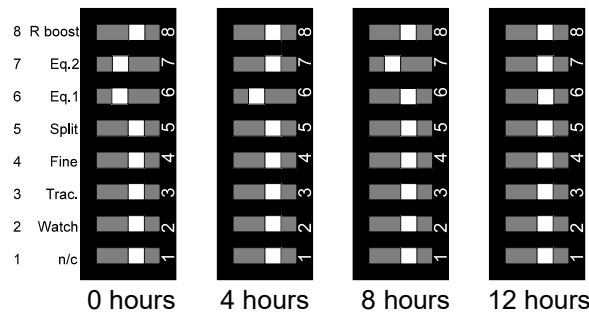

4.4 Diode-splitter charge voltage compensation.

If a diode-splitter (Victron Energy Argo) is connected to the Skylla charger the charge voltage has to be raised to compensate for the voltage loss over the diode-splitter.

If the voltage-sense option is used, do not use the diode-splitter compensation. When both options are used simultaneously the output voltage will be too high.

To select the diode-splitter option:

- Place DIP switch 5 “split” to the left.

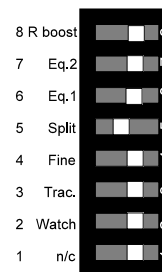

4.5 Traction battery compensation

If a Traction-battery is connected to the Skylla charger the charge voltages have to be changed. The output voltage has to be raised to correctly charge the traction-battery. It is possible that the charge voltages are not correct after activating this compensation. See for adjusting the charge voltages chapter 4.2.

To set the charger into the traction mode:

- Place DIP-switch 3 "trac" to the left.

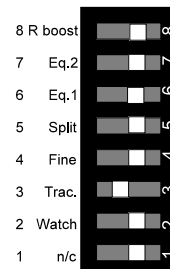

4.6 Use as a power-supply

The Skylla charger can be used as a power supply without the obligation to connect a battery to the charger output.

To use the charger as a power supply:

- Put the charger into the permanent boost-charge mode, see chapter 4.1.
- Adjusted the output voltage to the desired voltage, see chapter 4.2.

With the above mentioned procedure the output voltage range is limited. When the full output voltage range is required please contact your Victron Energy dealer. See chapter 6.3 for details.

4.7 Use of a temperature sensor.

The temperature sensor supplied with the charger can be connected to the charger by using the 3 meter cable with stripped and tinned cable ends. This sensor should be mounted on the battery. The temperature sensor adjusts the charging voltage according to the battery temperature.

To connect the temperature sensor:

- Disconnect the mains,
- Connect the - (black wire) of the temperature sensor to the "-tmp" connector, see illustration 8.
- Connect the + (red wire) of the temperature sensor to the "+ tmp" connector, see illustration 8.
- Switch on the mains.
- If the temperature sensor is correctly connected the "TMP OK" on the printed circuit board led illuminates. If this led does not illuminate or flashes, the sensor is not connected correctly.

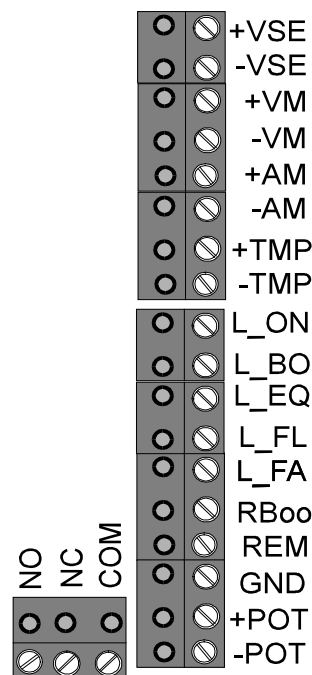

Illustration 8.
Location of the external connections.

4.8 Charging batteries with voltage sensing



Do not use the voltage sense facility in combination with the diode-splitter compensation, as this will raise the output voltage.

When high current runs through a thin cable between the charger and the battery there will be a voltage loss in the cables. The charging voltage measured at the battery poles will be lower than the specified voltage and this will result in a longer charging time. However, the charger is equipped with a voltage sense facility. The battery voltage is exactly measured and the charger increases the output voltage to compensate for the voltage loss across the cables.

The charger can compensate for a maximum of 2V voltage loss over the cables. When the voltage loss is bigger than 2V the “on” led flashes and the failure led illuminates. The charge voltage will decrease until the voltage loss becomes maximum 2 Volt. The “on” led flashes and the failure led illuminates until the charger is manually switched off. When this occurs the battery cables have to be replaced because they are too thin or have bad connections.

To install the voltage sense option:

- Disconnect the mains.
- Connect a red 0,75 mm² wire to the positive battery pole and the “+Vse” connector of the charger, see illustration 8.
- Connect a black 0,75 mm² wire between the negative pole of the battery and the “-Vse” connector of the charger, see illustration 8.
- For properly functioning both wires have to be connected.
- Switch on the mains.
- The “VSE OK” led on the printed circuit board illuminates when connected correctly. If this led does not illuminate the voltage sense wires are wrongly connected.

4.9 Intelligent startup

The factory setting of the charger is such that the battery voltage is checked when the charger is switched on (intelligent startup). In the case of a flat battery, the charger will start charging in the boost mode. If the battery voltage is sufficiently high during charger startup, the charger will be charging in the float mode. In some situations it may be desirable for the charger not to check the battery voltage upon startup. With this charger this function is enabled by sliding dip switch 2 “Watch” to the left.

When this dip switch is positioned on the left, the charger will always start charging in the boost mode.

When dip switch 2 “Watch” is positioned on the right, it is checked upon startup whether the battery voltage is sufficiently high to enable a start in the float mode. If it is not, the charger is started in the boost mode as yet.

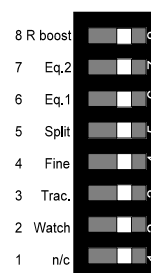

4.10 Connecting the output voltage alarm

The charger is equipped with a potential free alarm contact (change over type). If the battery voltage is in between V_{min} and V_{max} the contact is activated. (See figure 8, remote connections: NO, NC, COM).

Model	V_{min}	V_{max}
24V	23,8 Vdc	33,5 Vdc

4.11 Connecting remote panels

Victron Energy provides two optional remote panels that can be connected to the charger. See illustration 8 for the circuit board connector where the remote panels have to be connected to.

The COV panel:

The maximum charging current of 30A, 50A or 100A, according to the model, can be limited with an external panel. This panel, the Victron Energy COV panel, contains an adjustable potentiometer. Limiting the maximum charging current can be useful to meet the batteries specifications, or to make sure the shore fuse does not blow.

To connect the panel:

- Disconnect the mains.
- Connect the panel to the “+ pot” and “-pot” connector.

The CMV panel:

This panel indicates the charging mode and possible failures.

To connect the panel:

- Disconnect the mains.
- Connect the boost led to the “L_BO” connector.
- Connect the equalize led to the “L_EQ” connector.
- Connect the float led to the “L_FL” connector.
- Connect the failure led to the “L_FA” connector.
- Connect the ground of the panel to the “GND” connector.

The CSV panel:

With the CSV panel the charger can be switched on or off. On the panel a green “on” led is present. To operate the CSV panel you first have to switch the charger on with the on/off switch located on the front panel of the charger.

To connect the panel:

- Disconnect the mains
- Connect the on led to the “L_ON” connector.
- Connect the ground of the panel to the “GND” connector.
- Connect the “TG switch” to the “REM” connector.

The SKC panel:

This panel indicates if the charger is on or off, it indicates the charging mode and it contains an adjustable potentiometer. Limiting the maximum charging current can be useful to more accurately charge the batteries according to the manufacturers specifications, or to make sure the shore fuse does not blow.

To connect the panel:

- Disconnect the mains.
- Connect the on led to the “L_ON” connector.
- Connect the boost led to the “L_BO” connector.
- Connect the float led to the “L_FL” connector.
- Connect the ground of the panel to the “GND” connector.
- Connect current control to the “+ POT” and “-POT” connector.

4.12 Connecting a remote on/off switch

A remote switch can be connected to the charger so the charger can be switched on and off from a remote location. To operate the switch, first switch the charger on with the on/off switch located on the charger.

To connect the remote on/off switch:

- Disconnect the mains.
- Connect the switch in between the “REM” and the “GND” connector.

4.13 Connecting a remote boost switch

A remote switch can be connected to the charger so the charger can be switched permanently into the boost-charge mode. Due to parallel loads connected to the battery it is advised to switch the charger into the permanent boost-charging mode in order not to discharge the battery.

If the switch is closed the charger switches into the permanent boost-charge mode. If the switch is opened again the charger will automatically go to the float-charge mode. This in order not to overcharge a battery with charging it to long with higher charging voltage.

To connect the boost switch:

- Disconnect the mains.
- Connect one pole of the switch to the “RBOO” connector.
- Connect the other pole of the switch to the “GND” connector.

4.14 Connecting a voltmeter

The remote-connector offers a possibility to connect a voltmeter. It is possible to connect a digital as well as an analogue voltmeter. This output can only be used when the voltage-sense is connected. The voltage at this output is equal to the voltage measured at the point where the voltage sense wires are connected.

Connecting a voltmeter

- Disconnect the mains voltage.
- Make sure that the voltage sense wires are connected, see chapter 4.8.
- Connect a black wire between the “-” connection of the voltmeter and “-VM” at the remote connector.
- Connect a red wire between the “+” connection of the voltmeter and “+VM” at the remote connector.
- Connect the mains voltage.

4.15 Connecting a ampèremeter

The remote connector offers a possibility to connect an ampèremeter, which indicates the output current of the charger. For the 30A charger an ampèremeter, which indicates 30A at 60mV input voltage is required. For the 50A charger an ampèremeter, which indicates 50A at 60mV input voltage is required, likewise for the 100A charger an ampèremeter, which indicates 100A at 60mV input voltage is required.

Connecting an ampèremeter

- Disconnect the mains voltage.
- Connect a black wire between the “-” connection of the ampèremeter and “-AM” at the remote connector.
- Connect a red wire between the “+” connection of the ampèremeter and “+AM” at the remote connector.
- Connect the mains voltage.

5. FAULT TRACING

When a fault occurs in the battery charger, the following table can be used in order to find the fault. Before the Skylla is being checked, make sure that all the devices connected to the battery charger are removed. If the fault can not be solved, please contact your Victron Energy dealer.

Problem	Possible cause	Solution
The charger does not operate	The mains voltage has to be in between 90Vac and 265 Vac.	Measure the mains voltage and make sure it is in between 90Vac and 265Vac.
	A broken input fuse.	Return the charger to your dealer.
The battery is not being fully charged	The equalize-charge mode is set to a too short period.	Set the equalize-charge mode to a longer time.
	A bad battery connection.	Check the battery connections.
	The boost charge voltage is set to a wrong value.	Adjust the boost charge voltage to the right value.
	The float charge voltage is set to a wrong value.	Adjust the float charge voltage to the right value.
	The capacity of the battery is too large.	Connect a battery with a smaller capacity or install a larger charger.
	The output fuses are broken.	Replace the output fuses.
The battery is being overcharged	The battery charger is set into the permanent boost-charge mode.	Deselect the permanent boost DIP-switch (Rboost).
	The boost charge voltage is set to a wrong value.	Adjust the boost charge voltage to the right value.
	The float charge voltage is set to a wrong value.	Adjust the float charge voltage to right value.
	A bad battery.	Check the battery.
	The battery is located in a warm place	Connect a temperature sensor
	The battery is too small.	Reduce the charge current.
The failure led illuminates	The charger is switched off as a result of a high ambient temperature.	Place the charger in a cooler, or better ventilated place.
The failure led flashes	The charger is reducing the output current as a result of a high ambient temperature.	Place the charger in a cooler, or better ventilated place.
The failure led flashes in a code ¹	The output fuses are broken.	Replace the output fuses.
The failure led illuminates in combination with a blinking on/off led	There is a voltage drop higher than 2V across the battery cables.	Turn the charger off, replace battery cables and connect them well.



A qualified technician may only remove the cover of the Skylla. Before obtaining access to the Skylla the mains supply circuit must be disconnected.

¹Flashing code sequence is two times on in one second and then one second off.

6. TECHNICAL SPECIFICATIONS

6.1 General

Switch on behaviour	Charger can switch on under every load
Temperature range	0 °C until +40 °C, decreasing output power if temperature > +40 °C
EMC Emission	According Council Directive 89/336 EEG EN 55014 (1993) EN 61000-3-2 (1995) EN 61000-3-3 (1995)
Immunity Vibration	EN 55104 (1995) IEC 68-2-6 (1982)
Safety GL approval	EN 60335-2-29 (1991) Environmental category C, EMC 1 Certificate no 54 758 – 08HH

6.2 Input

Input voltage range	90 - 265 Vac, full output power available (exception: output of the 24/30 at 110Vac: 22 A)
Frequency range	45 - 65 Hz, full output power available
Maximum Input current	At 90V ac input voltage :
Model: 24/30	12A at 30V / 30A
24/50	20A at 30V / 50A
24/100	40A at 30V / 100A
Cos phi / power factor	1,0

6.3 Output

Model	TG 24/30	TG 24/50	TG 24/100
Boost charge voltage	28,50 Vdc	28,50 Vdc	28,50 Vdc
Float charge voltage	26,50 Vdc	26,50 Vdc	26,50 Vdc
Output voltage range	24-33Vdc	24-33Vdc	24-33Vdc
Output voltage range supply mode ²	0-33Vdc	0-33Vdc	0-33Vdc
Charge characteristic	IUoUo	IUoUo	IUoUo
Voltage compensation for diode-splitter, via DIP-switch	+ 0,6 V	+ 0,6 V	+ 0,6 V

Model	TG 24/30	TG 24/50	TG 24/100
Current/voltage stability	± 1 %	± 1 %	± 1 %
Boost charge voltage compensation for traction battery, via DIP-switch	+ 2,0 V	+ 2,0 V	+ 2,0 V
Maximum output current	30A	50A	100A
Output current range	0-30A	0-50A	0-100A
Output voltage ripple measured with a 30A, 50A or 100A resistive load	<100mVtt	<100mVtt	<100mVtt
Maximum output power	750W	1500W	3000W
Short circuit current	27.5A	55A	100A
Maximum starter battery current	4A	4A	4A
Low battery alarm relay	23,8 Vdc ±0,8Vdc	23,8 Vdc ±0,8Vdc	23,8 Vdc ±0,8Vdc
High battery alarm relay	33.5Vdc ± 0,8Vdc	33.5Vdc ± 0,8Vdc	33.5Vdc ± 0,8Vdc
Output fuse (flat car fuse)	2 x 20A	4 x 20A	8 x 20A
Leakage current from battery when the battery charger is turned off	≤ 3,2 mA	≤ 6,4 mA	≤ 6,4 mA

* 6,3mm x 32mm fuse 30A slow

² Contact your Victron Energy dealer for this option.

6.4 Mechanical

	TG24/30 and TG24/50	TG24/100
Cabinet	Aluminium sea water resistant	Aluminium sea water resistant
Protection	IP 21	IP 21
Colour	Blue (RAL5012), epoxy coated	Blue (RAL5012), epoxy coated
Dimensions	365 x 250 x 147mm	368 x 250 x 257mm
Dimensions including box	435 x 320 x 217mm	438 x 320 x 330mm
Weight	5,5 Kg	9.8 Kg
Weight including box	6,4 Kg	10.5 Kg
Input 230Vac connection	Connection block, suitable for wires up to 4 mm ²	Connection block, suitable for wires up to 4 mm ²
Battery connection	M8 bolts	M8 bolts
Earth connection	M5 hole at bottom of the cabinet	M5 hole at bottom of the cabinet
Temperature sensor connection	Connection block	Connection block
Starter battery connection	Connection block, suitable for wires up to 1,5mm ²	Connection block, suitable for wires up to 1,5mm ²
Cooling	Forced air cooling	Forced air cooling
Noise	< 45dB(A)	< 45dB(A)
Relative humidity	95% (maximal)	95% (maximal)

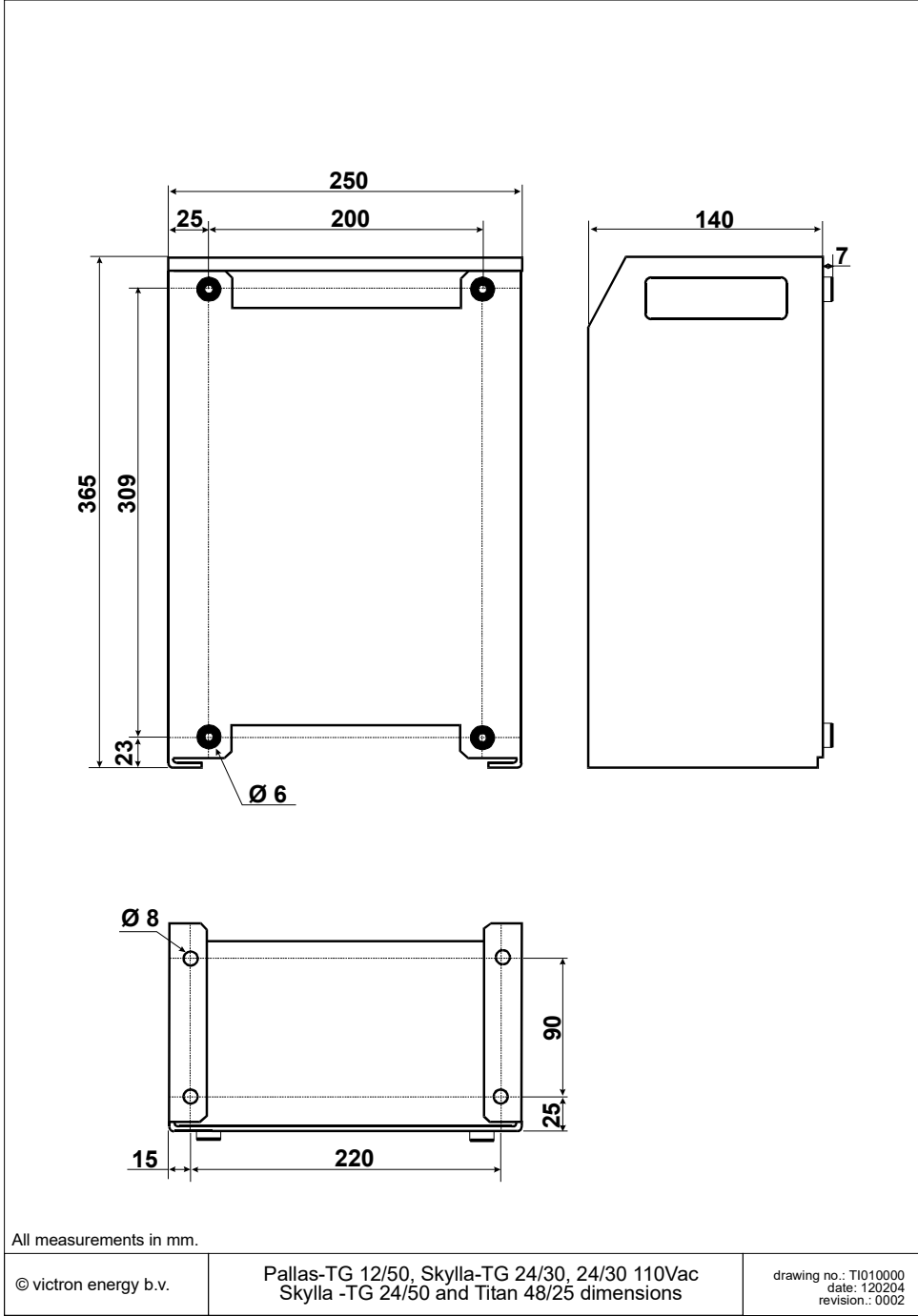

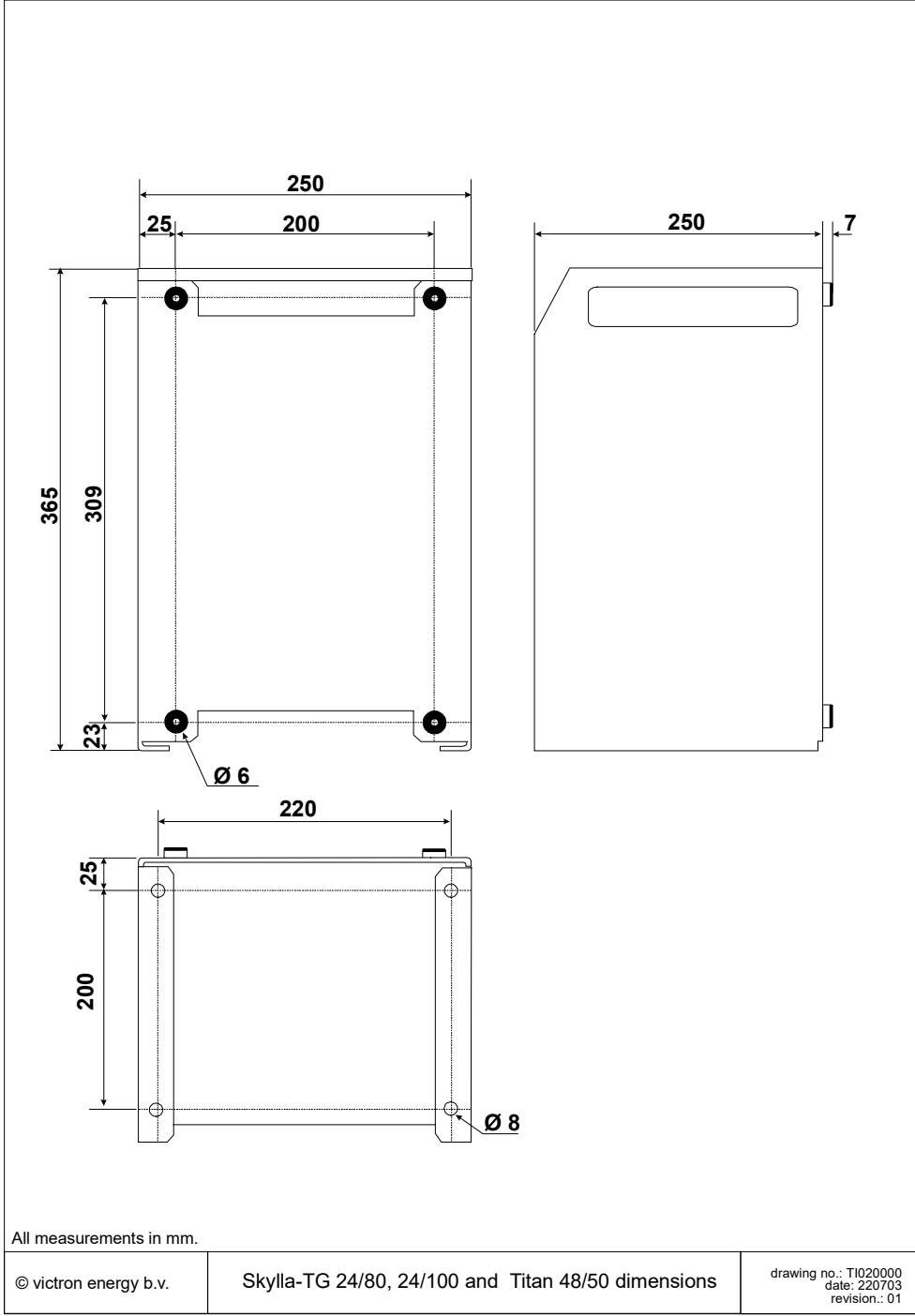

Victron Energy B.V.
The Netherlands

E-mail: sales@victronenergy.com
Internet site: <http://www.victronenergy.com>

Version: rev06
Date: 03-07-2019